

# EQStarPro User Guide



## Contents

1. Overview .....	3
2. Hardware Installation .....	5
3. PC Software Installation.....	6
4. PC control .....	8
5. Control with Mobile Cell Phone or Tablet.....	10
6. EQStarPro control via ZWO ASIAir Pro.....	14
7. EQStarPro control via a Linux Controller .....	15
8. Stand-alone mount control with push-button joystick.....	16
9. Additional Tips.....	17

## 1. Overview

The control system EQStarPRO is designed to automate the control of the equatorial mount, and can be used in stand-alone mode or in a control mode using a computer or mobile device (phone, tablet, etc.). For use with a PC, EQStarPRO works with any astronomical programs that support the ASCOM platform ( <http://www.ascom-standards.org/> ). For example, it works with planetarium programs like Stellarium, Cartes de Ciel, StarCalc and others. Among the programs for astrophotography and guiding, EQStarPRO supports MaximDL, Guidemaster, PHDGuiding and others. When you work with a PC, EQStarPRO allows you to automatically goto sky objects and track them automatically during astro photography with long exposures. When working with a PC, you must install the EQMOD ASCOM-application ( <http://eq-mod.sourceforge.net/> ).

Telescope control with mobile devices can automatically find sky objects in the planetarium program on mobile devices. The control of the telescope should be chosen as Celestron SynScan, as well as a mount - German equatorial mount. Compatible programs on mobile devices include SkySafari, Orion StarSeek, DSOPanner et al.

EQStarPRO Communication with the PC is via the USB cable from the standard equipment, while mobile devices use a WiFi interface.

A variety of platforms, drivers, and applications can control EQStarPRO, making it possible for the user to point the telescope on the mount to any object selected in a planetarium program or create automated astrophotography sessions that cause the telescope to point to a series of objects or locations and control guided imaging. For example, an astro photographer generally uses a laptop or PC to point to an object, with targeting and guiding on the object during a long exposure. Such opportunities are mostly programs running under Windows. But for an amateur interested in visual astronomy, it is much more convenient to control the mount with a compact mobile device, such as a smartphone or tablet, rather than using a PC or laptop.

In the EQStarPRO kit is a universal mount a joystick for manual control as well. It also allows you to control mount autonomously without a computer, smartphone or tablet.



EQStarPRO Inputs, Outputs, and Control

- ST4: ST4 hand controller or guiding input.
- PC: COM port over USB interface for PCs.
- Wifi: Wifi enable switch
- Wifi On LED
- Power on/off switch
- Power input: 5.5mm outer, 2.1mm inner power connector. (accepts center 2.1mm male plus pin and 5.5mm outer ground sleeve)
- RA and DEC stepper motor control RJ45 connectors.

## 2. Hardware Installation

2.1. Install the drive motors on the mount axes as shown in the following pictures.



## 2.2. Motor Installation tips:

2.2.1. The motor mount needs to be adjusted to get a reasonable belt tension (tight enough to avoid belt slippage, loose enough to avoid excess mechanical wear). The belt should not sag, but there should be some play pushing against the belt with your finger.

2.2.2. Connect the mount control unit to each motor using the cables supplied with EQStarPRO.

2.2.3. Motor control cable connector pinouts:

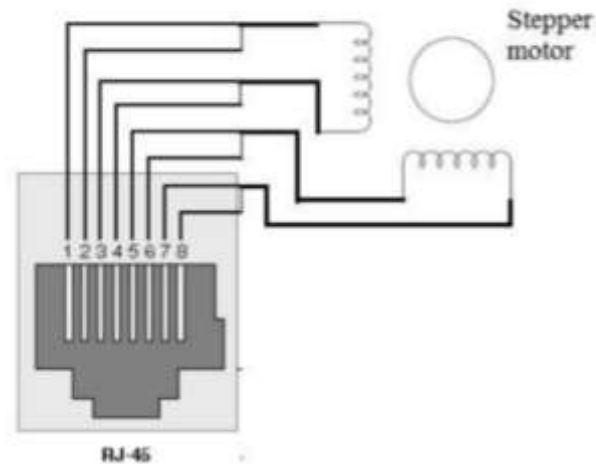

## 3. PC Software Installation

3.1. Install the driver virtual com-port software from the supplied CD

The driver can be found in the 'DriverVertComPort' directory of the CD. Choose either the x64 or x86 driver based on whether your PC supports x64 or not. The x64 installer executable is named 'CP210xVCPInstaller\_x64.exe'. This installs a Silicon Labs CP210x USB UART driver.

After you install the driver, when you connect the EQStarPro via the supplied USB cable, the driver will show up as managing the virtual COM port in the Windows Device Manager (start that by typing 'Device Manager' in the Windows tool bar search line). The details for this connection are under the LPT/COM heading. For example, you will see an entry for

Silicon Labs CP210x USB to UART Bridge (COMx)

Note the virtual COMx port name for use in later software installation steps, for example COM3.

3.2. Install the ASCOM Platform 6.x. (<http://www.ascom-standards.org>).

Note the supplied CD has a copy of this software, but the above web site should have the latest version.

3.3. Install the EQMOD Ascom driver located on the CD software.

The supplied CD has a copy of this software. The latest version is available from <https://sourceforge.net/projects/eq-mod/>.

3.4. Connect the control unit to the computer with the supplied USB cable.

3.5. Connect the control unit to 12V power via a user-supplied cable with a 5.5mm x 2.1mm power plug.

After the power switch on the EQStarPro is turned on, the unit will sound 1 short, then 3 short and 1 long beep that indicates the EQStarPro is ready.

3.6. Observe the setting of the control unit using the EQStarPRO setting program on the CD software.

The settings program can be found in the 'EQStarPRO settings' directory on the CD.

**Note this program requires the .NET 4.0 framework and VS2013 x86 redistributable to run.**

The virtual COM port used by the settings program defaults to COM4, but can be changed in the settings panel to the one noted above in the Windows Device Manager if it is different.

**To see or set the current settings of the EQStarPro, that unit must be started in the settings mode.**

With the unit powered off, connect the joystick remote control to the ST4 port of the EQStarPro. While pressing the 'Mode' button on the side of the manual remote control, turn the power on for the EQStarPro. It should respond with two short beeps to indicate it is in the settings mode.

In the EQStarPro settings panel, click on 'Load settings' to see the current settings of the unit.

The EQStarPro kit should come with the EQStarPro correctly set for the mounts supported by this kit. Of particular importance is the RA and DEC gear ratios. For example, at least the LX75 and Vixen GP mounts have 144 tooth worm gears on both axes, so the gear ratio should be set to 576 (144 x 4, where 4 is the step-down ratio from the stepper motor gear to the worm shaft gear).

This program also allows adjusting the GoTo speed, motor current, and acceleration for each axis. The EQStarPro supports up to x2000 goto speed. Motor current affects the load capacity of the telescope mount, but also affects how much noise the stepper motors emit.

If the settings do not meet the required settings for your mount, change and save the settings.

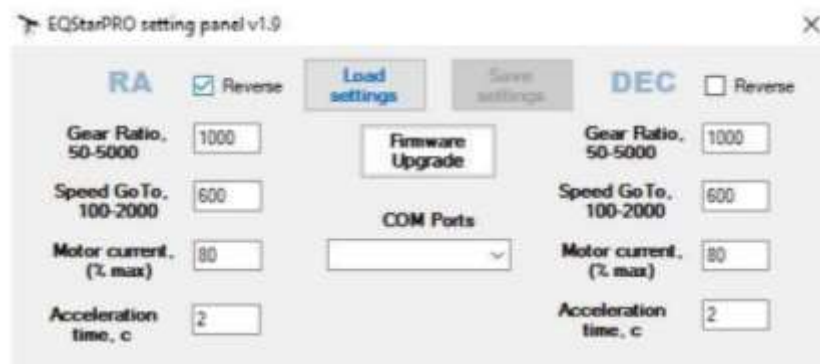

## 4. PC control

### 4.1. Automatic Find (GoTo)

Before beginning work in this mode, the PC must have the ASCOM platform and the EQMOD telescope driver installed. See the previous section.

Next, in a planetarium program on your PC, configure the program to select the ASCOM telescope EQMOD, and set the COM port name to the virtual COM port listed in Windows device manager, a COM/LPT entry labelled 'CP210X USB to UART Bridge (COMx)'. Name this telescope connection 'EQStarPro' for further reference and tell the planetarium to use this telescope instance.

See the tutorial for EQMOD at <http://eq-mod.sourceforge.net/tutindex.html> for further details on binding the telescope to the planetarium program.

The mount of a telescope should be positioned in the 'Polar Home' position with the RA and DEC axes pointing toward the pole star. The telescope counter weight should align with the north-pointing mount leg, and the telescope should point toward Polaris. Many mounts have markers to assist in accurately setting this position.

Once this setup is complete, you can select a target object in the planetarium program and request the telescope slew to that object. After slewing, the object should be visible through the telescope.

For example, with Stellarium, once the EQStarPro configuration information is set up using the 'wrench' settings icon, telescope control can be enabled via the telescope icon. This brings up the ASCOM control panel that shows the current settings of the telescope and allows manual control of the telescope. Once an object is selected in the planetarium view, the telescope can be slewed to it. If the object is not centered in the display, the ASCOM panel can be used to manually slew the telescope to center the object.

### 4.2. Long Exposure Astro-photography

To take long exposure photos of space objects, pointing errors of the telescope can blur the final photo. To correct this, EQStarPro supports two automatic guiding approaches: automatic guidance using the ST-4 port on the EQStarPro, or pulse guiding using the ASCOM interface. Both modes are set from the EQMOD application panel. Pulse guiding does not require cables in addition to the USB cable connecting EQStarPro to the PC.

See ([http://eq-mod.sourceforge.net/docs/EQASCOM\\_Guiding.pdf](http://eq-mod.sourceforge.net/docs/EQASCOM_Guiding.pdf)) for more details on configuring these modes.

Automatic guiding can be handled via the ASCOM interface via guiding programs like PHD2, MaximDL, and Guidemaster. These programs require snapshots of the target sky area to stabilize the pointing of the telescope based on a guide star in the field of view. These snapshots can be provided via an auxiliary guide scope with its own imager, an off-axis guider and imager, or primary images of the target area.



#### 4.3. Guiding using the ST-4 port

The ST-4 port on the EQStarPro can also be used with an external guider like the Skywatcher standalone SynScan guider.

To get the EQStarPro to accept guiding via the ST-4 port, connect the joystick remote and press and hold the mode button (side of joystick box) for 5 seconds. EQStarPro will respond with a long beep. The default guiding speed for each axis is x0.5. Pressing the RA + button up to three times will result in x0.5, x0.75 and x1.0 speeds. Similarly, 'DEC +' button presses change the DEC guide speed from x0.5 to x0.75 to x1.0. The EQStarPro will respond with appropriate beeps as these changes are made.

Now disconnect the joystick and connect the autonomous guider to the ST-4 port.

To deactivate the ST-4 guiding mode, press and hold the joystick 'mode' button again for 5 seconds.

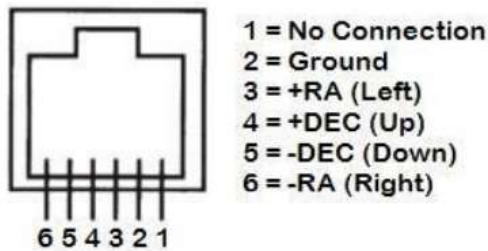

Pinout port ST-4 EQStarPRO

## 5. Control with Mobile Cell Phone or Tablet.

For control via an Android cellphone or tablet, the telescope mount needs to be set up with mount axis stepper motors and cabling to the EQStarPro as specified in section 3.1 and 3.2. SynScan Pro is required on the cellphone to control the mount via WiFi, and the cellphone needs to be connected to the EQStarPro WiFi network (SSID name EQStarPro). The SynScan Pro app for Android is supplied with the EQStarPro CD, and is also available on the Goggle Play app store.

SynScanPro is sufficient to enable mount alignment and goto based on its list of stars or deep sky objects or a specific RA/DEC coordinate. Alternately, the SkySafari 6.0+ planetarium app can be used to control goto functionality by connecting that app to a running version of SynScanPro.

Other supported mobile applications include Orion StarSeek, DSOPlanner or others.

### 5.1. Install SynScan Pro

Install SynScan Pro from the CD supplied with the EQStarPro kit, or from the Google App Store. Note that this application only works with Android 10 and lower according to the current Google Play App Store notes. Those notes suggest getting a newer version of SynScan Pro from the SynScan Pro product web site for newer versions of Android.

### 5.2. Set Telescope in Polar Home Position

Set the telescope and mount in the polar home position with the mount leveled, weights pointing straight down, and telescope tube pointed toward Polaris. The LXD75 mount (and likely others) has arrows on the mount axes that align when this position is reached.

### 5.3. Turn on WiFi and EQStarPro

Turn WiFi mode via the switch on the front panel of the unit and turn on the EQStarPro power. After power on you will hear a beep, indicating the EQStarPRO mount is ready for control, and the WiFi mode indicator LED will be lit.

### 5.4. Connect to WiFi SSID EQStarPro

Connect the cell phone to the WiFi network with the SSID EQStarPro. Start the SynScan Pro application. You should see the SynScan Pro home screen indicating a connection to an 'EQ6' mount. After connecting to the EQStarPro, set the observer location in the app (settings -> location), then go through the alignment procedure available from the SynScan Pro app 'alignment' icon. Further operation of this application is beyond the scope of this manual, but a downloadable PDF manual for SynScan Pro is available from their web site.

[https://www.telescope.com/assets/product\\_files/instructions/Synscan\\_App\\_Users\\_Manual.pdf](https://www.telescope.com/assets/product_files/instructions/Synscan_App_Users_Manual.pdf)

### 5.5. Start a Viewing Session

A viewing session requires first unparking the mount via SynScan Pro with the telescope in the polar home position. At the end of a viewing session, return the telescope to the polar home position by parking it again in SynScan Pro.

## 5.6. SynScan Pro screen:

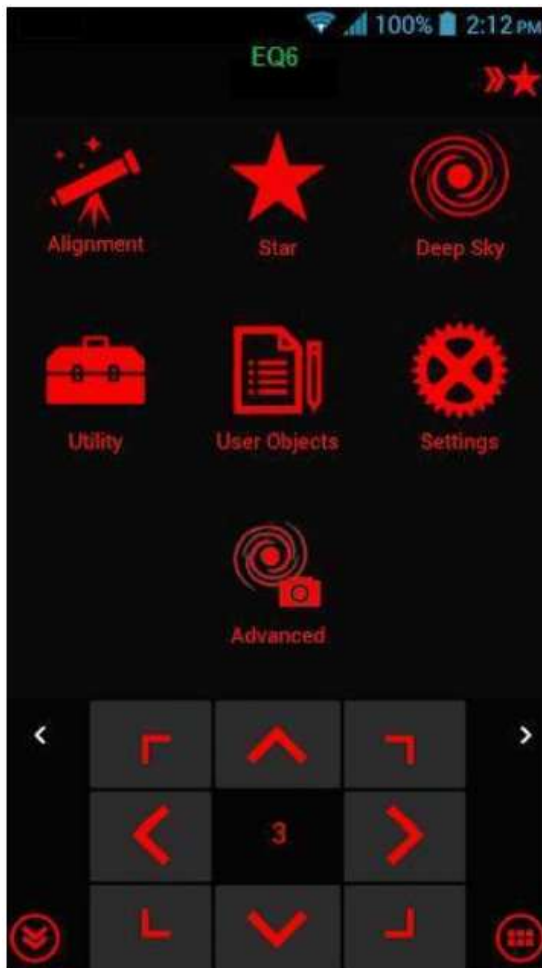

## 5.7. EQStarPro WiFi Settings Configuration via SynScan Pro

By default, the EQStarPRO operates in Access Point mode, with an SSID of EQStarPro and no WiFi security password. The Settings -> Wifi Settings form in SynScan Pro can be used to set a password for better security.

## 5.8. Using SkySafari Planetarium for EQStarPro Control

SkySafari 6.0+ can be used from an Android cellphone to control goto operations using the SynScan Pro application via a local network connection to that app. SynScan Pro must be running along with SkySafari. In SkySafari, select a 'Wifi' connection with an IP address of 127.0.0.1 and port of 11882.

### 5.8.1. SkySafari Scope Settings Form

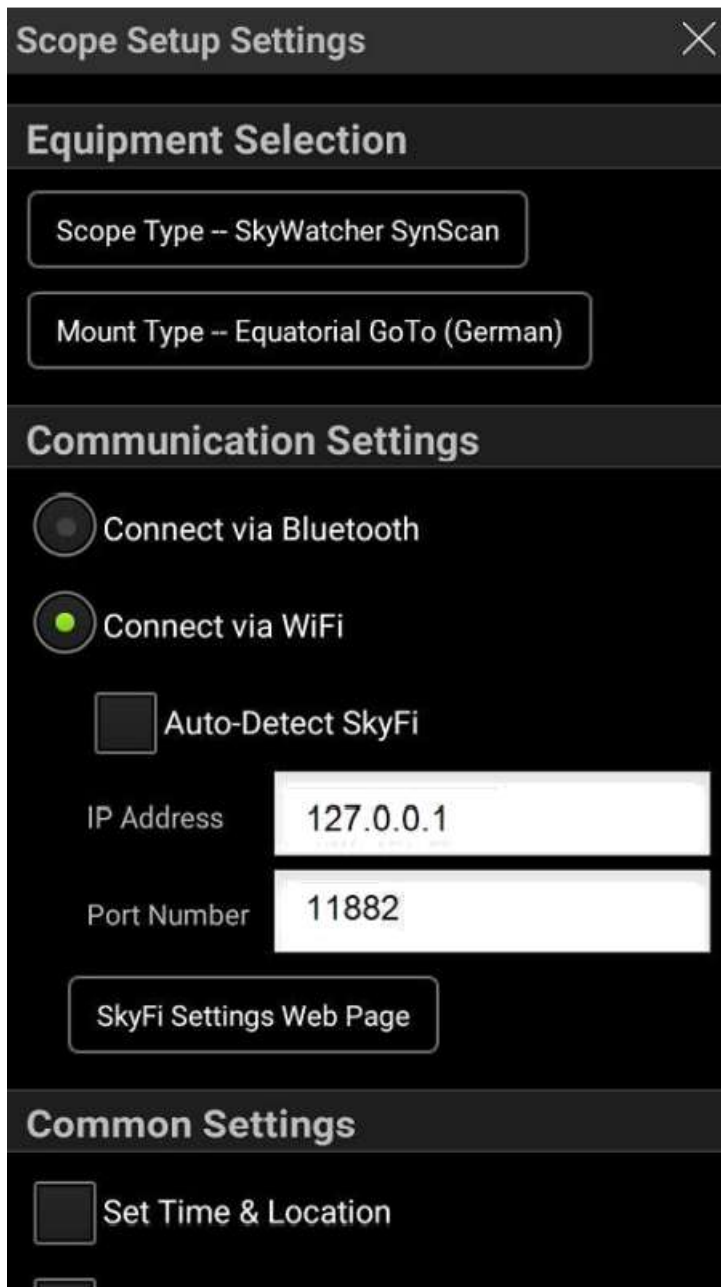

The screenshot shows a mobile application window titled "Scope Setup Settings" with a close button (X) in the top right corner. The window is divided into three main sections:

- Equipment Selection:** Contains two buttons: "Scope Type -- SkyWatcher SynScan" and "Mount Type -- Equatorial GoTo (German)".
- Communication Settings:** Contains radio buttons for "Connect via Bluetooth" (unselected) and "Connect via WiFi" (selected). Below these is a checkbox for "Auto-Detect SkyFi" (unchecked). There are two text input fields: "IP Address" with the value "127.0.0.1" and "Port Number" with the value "11882". A button labeled "SkyFi Settings Web Page" is located below the input fields.
- Common Settings:** Contains a checkbox for "Set Time & Location" (unchecked).

### 5.8.2. SkySafari Goto Operation

Once the connection is made to the EQStarPro via the SynScan Pro application, SkySafari can be used to select an object and request telescope Goto to point at that object. Once slewing stops, the requested object should be in view through the telescope. If that object is not in view, the telescope may need pointing adjustments via the SynScan Pro pointing controls. Once the

object is in view, sync to that object in SynScan Pro to correct the pointing accuracy near this object.

### 5.9. iOS Devices and EQStarPro

iOS devices also can control EQStarPro via SynScanPro and SkySafari Pro downloaded from the Apple App Store.

For SkySafari Pro to work on iOS devices, you will need to install an application called "SynScanLink". After downloading SynScanLink to the iPhone, the SkyWatcher SynScanLink telescope appears in the Skysafari telescope list. Use this choice and the Skysafari Pro and SynScanPro apps will communicate with each other via SynScanLink and you can control the mount with the Skysafari Pro.

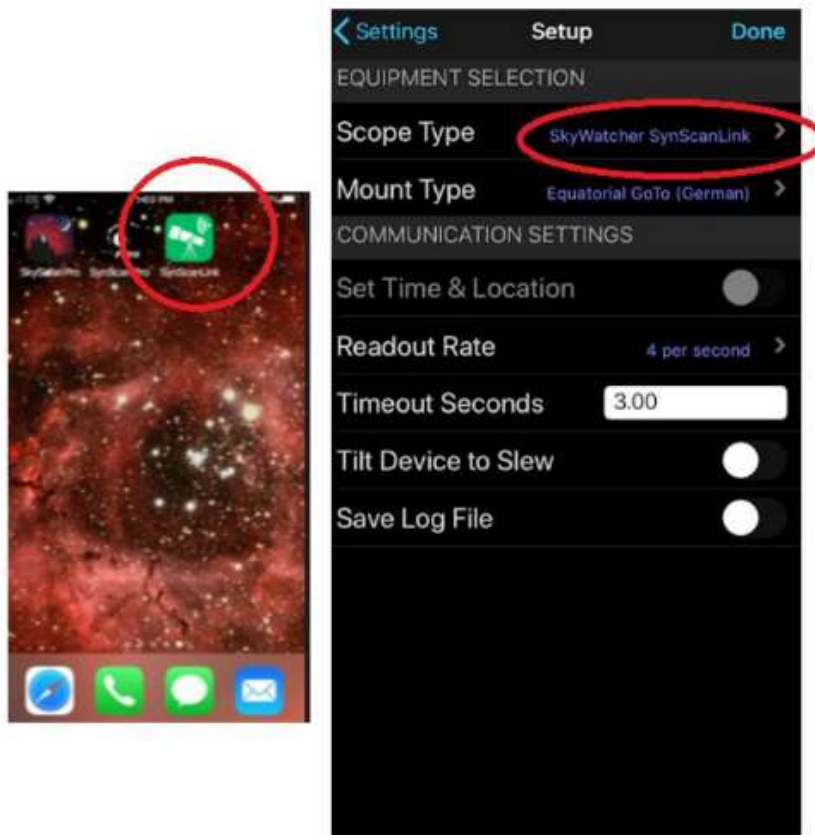

The SkySafari Pro app may need to be reinstalled after adding the Synscanlink app. Also, tracking will not occur if it is not enabled in Synscan Pro (by unparking the mount).

## 6. EQStarPro control via ZWO ASIAir Pro

The ZWO ASIAir Pro astronomic controller is a popular control box for scripted automated astrophotography, for use principally with ZWO imagers. (see <https://astronomy-imaging-camera.com/product/asi-air-pro> )

EQStarPro can be controlled via an ASIAir Pro controller via USB or WiFi.

### 6.1. ASIAir Pro control via USB

USB is likely simpler: just use the supplied USB cable connected to the PC port on the EQStarPro and to a USB port on the ASIAir.

In the telescope settings form of the ASIAir Pro, choose 'EQMOD with SkySafari' with a 9600 baud serial connection:

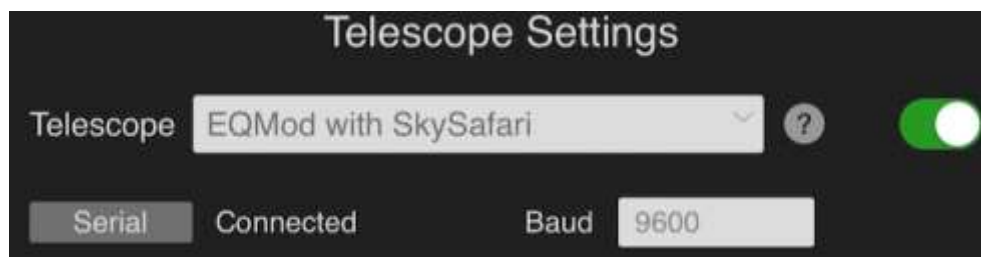

### 6.2. ASIAir Pro control via WiFi

For WiFi connections, the EQStarPro must be started with WiFi turned on. Slide the Wifi slider switch on the EQStarPro to the right. If the EQStarPro is powered via the ASIAir Pro, turn both on at the same time. The EQStarPro should beep 3 times and the WiFi indicator LED should be lit.

Connect the ASI Air to your home network or the ASIAir Pro network. Once this is complete, launch the ASIAir app, turn on station mode and connect to the EQStarPro network.

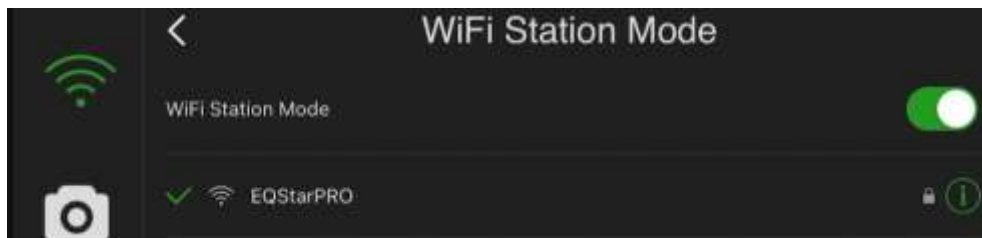

Finally, set the ASIAir Pro telescope settings to use 'EQMOD for SkySafari' with an IP address of 192.168.4.1 and port of 11880:

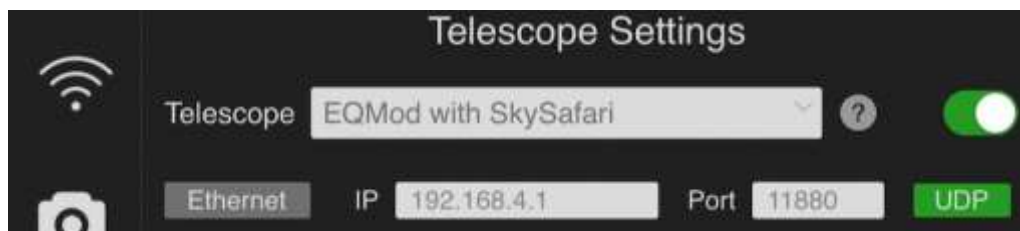

## 7. EQStarPro control via a Linux Controller

There are Linux open-source applications that can work with the EQStarPro via its WiFi interface. One such set is the KStars planetarium program paired with the Indi EQMOD plug-in. KStars contains a companion EKOS app for automated astrophotography control.

The Linux operating system could be any of a number of Linux distributions, including UBUNTU, Mint, or Redhat running on a laptop or standalone controller. Control is accomplished via the Indi astronomical control WiFi interface.

The KStars planetarium program can be paired with the Indi EQMOD plug-in to provide goto control.

Note that goto operations can use astrometry-based plate solving looking for identifiable stars in a post-goto image to refine the telescope pointing automatically to center the KStars-requested object.

KStars also has a companion EKOS app that supports scripted long exposure astrophotography sessions with auto guiding based on a guide camera as well as control of the primary imaging camera, including collecting captured images.

### 7.1. Linux applications for control

For Linux-based control of EQStarPro, the combination of KStars (a planetarium program) and EKOS (a mount control program for scripted, guided astrophotography) will work with the addition of an Indi-EQMOD package for KStars/EKOS. All this software is available from the KStars package manager. While KStars is available from several Linux package managers, the Indi-EQMOD is not. It is better to install all this software from the KStars package manager at ppa:mutlaqja/ppa.

Command lines to do this:

```
sudo apt-add-repository ppa:mutlaqja/ppa
```

```
sudo apt-get update
```

```
sudo apt-get install indi-full kstars-bleeding
```

```
sudo apt-get install indi-eqmod
```

### 7.2. Linux Control via KStars/EQMOD

7.2.1. When the EQStarPro USB cable is plugged into the Linux controller, it shows up as /dev/ttyusb0 (or similar). The 'lsusb' command should list it.

7.2.2. KStars has a device manager where the indi\_eqmod\_telescope device can be added pointing to this ttyusb0.

7.2.3. KStars has an optional telescope control panel that can be enabled to manage control of the telescope, including slewing or synching to the active object in KStars, parking or unparking the telescope, and stopping the mount in case of problems.

### 7.3. KStars documentation:

7.3.1. KStars: <https://docs.kde.org/trunk5/en/kstars/kstars/>

7.3.2. EKOS: <https://docs.kde.org/trunk5/en/kstars/kstars/tool-ekos.html>

7.3.3.Indi-EQMOD: <https://indilib.org/telescopes/skywatcher/eqmod.html>

#### 7.4. EQStarPro control via AstroBerry Server for Raspberry PI

A Raspberry Pi microcontroller can be used to control the EQStarPro using the AstroBerry distribution. At minimum, a Raspberry Pi 3B is needed, but a Raspberry Pi 4 is recommended.

The AstroBerry Server precooked image has an official Raspberry Pi Linux OS plus KStars, EKOS, the Indi EQMOD plugin, and several planetarium programs, including Cartes du Ciel. See the documentation link below for further details.

AstroBerry web site: <https://www.astroberry.io/>

Online documentation can be found at

[https://www.astroberry.io/docs/index.php?title=Astroberry\\_Server](https://www.astroberry.io/docs/index.php?title=Astroberry_Server)

## 8. Stand-alone mount control with push-button joystick.



- 8.1. Connect a push button joystick to port ST4.
- 8.2. After turning on the power to the EQStarPro, the device will emit 1 short, then 3 short and 1 long beeps. This means the EQStarPRO is ready to go and the mount will automatically start tracking at stellar speed.
- 8.3. Changing the tracking speed is carried out with the Ra + button or the Ra- button while holding the MODE button. Each speed selection is confirmed by short beeps as follows: one beep for tracking stopped, two beeps for star speed, three beeps for lunar speed, and four beeps for solar speed.
- 8.4. Changing the positioning (pointing) speed is carried out by the DEC + button or the DEC- button while holding the MODE button. Each choice of speed is confirmed by long beeps as follows: one beep - x20 speed, two beeps - x65 speed, three beeps - x200 speed and four beeps - x500 speed.



## 9. Additional Tips

- 9.1. The power plug on the EQStarPro requires a 5.5mm outside diameter and a 2.1mm inner pin diameter. At least with the Meade LXD75 mount, the original power cable appears to be 5.5mm outside, but 2.5mm inside. As such it does not provide a reliable contact with the inner 2.1mm pin in the EQStarPro. The required cable is available from several vendors on Amazon.
- 9.2. The LED on the front of the EQStarPro is not a power indicator. It is a WiFi indicator that should be lit when WiFi is enabled via the WiFi switch on the front of the EQStarPro.

### Specifications:

- Mount type: equatorial
- Power requirements: 12V, 3A, 5.5mm plug 2.1mm
- The center pin power connector positive
- Compatible type stepper motor (not included): bipolar
- Stepper motor windings current: adjustment, 2,5 A (max.)
- Gear ratio of RA and DEC: adjustable (from 1: 100 to 1: 5000)
- Smooth acceleration and deceleration of the stepper motor